

# OPERATING INSTRUCTIONS AND PARTS LIST FOR

## CRAFTSMAN RADIAL SAW

9 INCH

### MODEL NUMBER 103.29310

The model number of your Radial Saw will be found on the name plate on the tube cap. Always mention this model number when communicating with us regarding your Radial Saw or when ordering parts.

### HOW TO ORDER REPAIR PARTS

All parts listed herein may be ordered through SEARS, ROEBUCK AND CO. or SIMPSONS-SEARS LIMITED. When ordering parts by mail from the mail order house which serves the territory in which you live, selling prices will be furnished on request or parts will be shipped at prevailing prices and you will be billed accordingly.

WHEN ORDERING REPAIR PARTS, ALWAYS GIVE THE FOLLOWING INFORMATION AS SHOWN IN THIS LIST:

- |                     |                      |               |
|---------------------|----------------------|---------------|
| 1. The PART NUMBER. | 3. The MODEL NUMBER. | 103.29310     |
| 2. The PART NAME.   | 4. The NAME of item. | 9" RADIAL SAW |

### COAST TO COAST NATION-WIDE SERVICE FROM SEARS FOR YOUR CRAFTSMAN POWER TOOLS



SEARS, ROEBUCK AND CO. and SIMPSONS-SEARS LIMITED in Canada back up your investment with quick, expert mechanical service and genuine CRAFTSMAN replacement parts.

If and when you need repairs or service, call on us to protect your investment in this fine piece of equipment.

**SEARS, ROEBUCK AND CO. - U.S.A.**  
**IN CANADA, SIMPSONS-SEARS LIMITED**

# CRAFTSMAN 9 INCH RADIAL SAW — MODEL NUMBER 103.29310

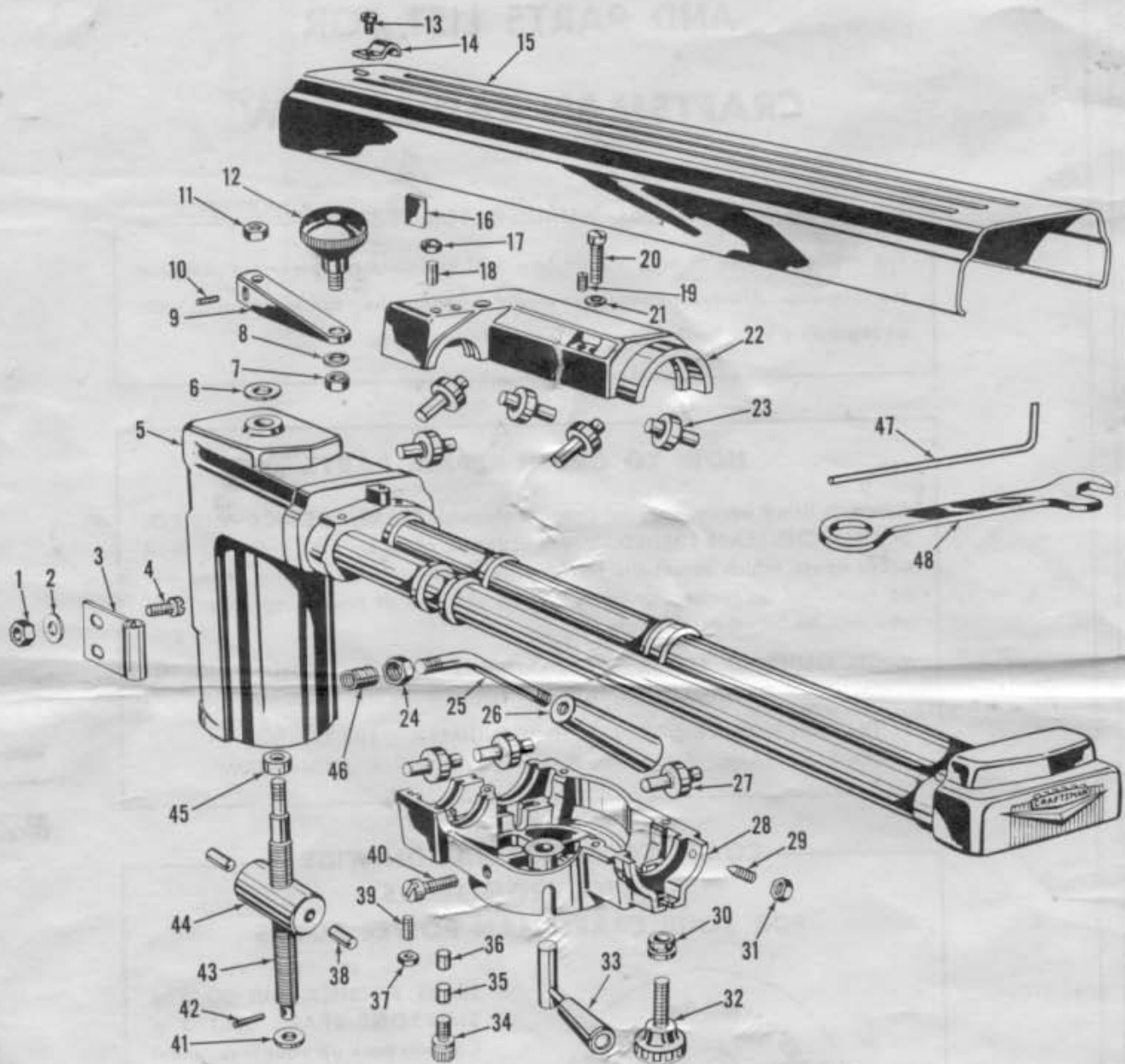

Fig. 1

## CRAFTSMAN 9 INCH RADIAL SAW — MODEL NUMBER 103.29310

WHEN ORDERING REPAIR PARTS, ALWAYS GIVE THE FOLLOWING INFORMATION AS SHOWN IN THIS LIST:

- |                    |                                     |
|--------------------|-------------------------------------|
| 1. THE PART NUMBER | 3. THE MODEL NUMBER — 103.29310     |
| 2. THE PART NAME   | 4. THE NAME OF ITEM — 9" RADIAL SAW |

Do Not Use Key Numbers When Ordering Repair Parts—Always Use Part Numbers

### PARTS LIST

Key No.	Part No.	Description	Key No.	Part No.	Description
* 1	X-420	Hex Nut ¼-20	*24	X-403	Hex Jam Nut ½-20
* 2	X-607	Washer 17/64 I.D. x 19/32 O.D. x 18 Ga.	25	59635	Lock Handle
3	59180	Rod and Plate Ass'y.	26	59643	Lock Handle
4	X-546	Mach. Screw ¼-20 x ¾	27	59810	Shaft & Bearing Ass'y.
5	59105	Head & Tubes Ass'y.	28	59411	Lower Slide Carriage
6	X-603	Washer 17/32 I.D. x 1-1/16 O.D. x 3/32	29	X-3810	Cone Pt. Set Screw 10-24 x 5/8
7	X-495	Lock Nut 5/16-18	30	59818	Grommet
8	X-617	Washer 21/64 I.D. x 9/16 O.D. x 18 Ga.	*31	38511	Hex Nut 10-24
9	59736	Elevating Crankarm	32	59523	Knob
10	38793	Roll Pin ½ Dia. x 11/16	33	59650	Index Pin Ass'y.
11	X-496	Lock Nut ¼-28	34	38794	Knurled Screw
12	59522	Knob	35	59831	Rubber Plug
*13	X-388	Mach. Screw 10-24 x ¼	36	59519	Nylon Plug
14	59822	Clip	*37	38511	Hex Nut 10-24
15	59737	Cover	38	38876	Roll Pin ¼ Dia. x ¾
16	59819	Felt Pad	39	X-3809	Round Pt. Set Screw 10-24 x 5/8
*17	38511	Hex Nut 10-24	40	X-557	Mach. Screw 10-24 x 7/8
*18	X-3809	Set Scr. Round Pt. 10-24 x 5/8	*41	X-637	Washer 29/64 I.D. x ¾ O.D. x 16 Ga.
*19	X-3807	Set Scr. Round Pt. ¼-20 x ¾	42	38793	Roll Pin ½ Dia. x 11/16
*20	X 242	Mach. Scr. ¼-20 x 1¼	43	59615	Elevating Screw
21	X-605	Lock Washer 21/64 I.D. x ½ O.D.	44	59614	Elevating Swivel
22	59412	Upper Slide Carriage	45	59637	Spacer
23	59820	Shaft & Bearing Ass'y.	46	59631	Adjusting Screw
			*47	X-1407	Hex Wrench
			48	59739	Flat Wrench

\*Standard hardware items — may be purchased locally.

# CRAFTSMAN 9 INCH RADIAL SAW — MODEL NUMBER 103.29310

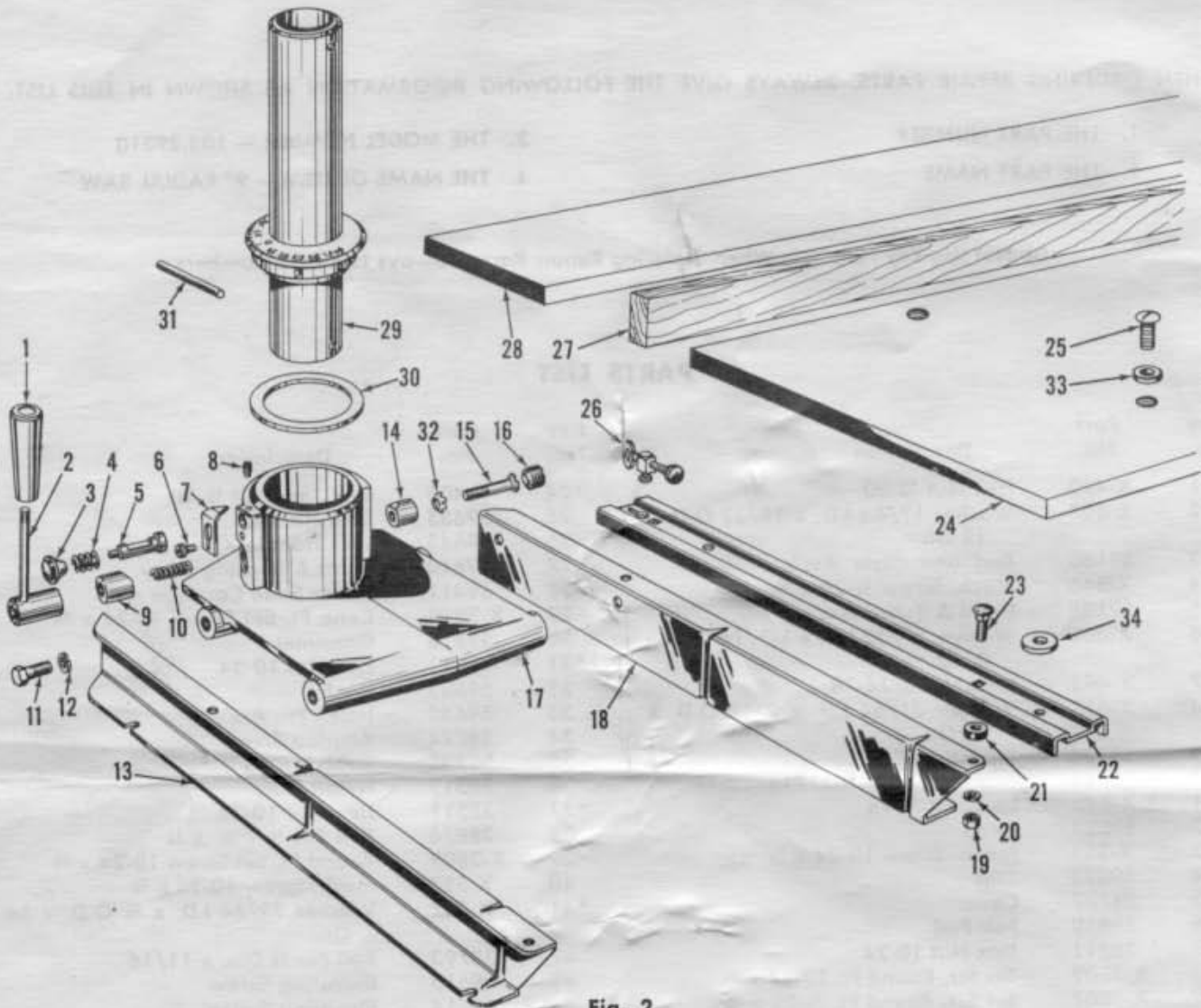

Fig. 2

Key No.	Part No.	Description	Key No.	Part No.	Description
1	59643	Knob	*20	X-607	Washer 17/64 I.D. x 19/32 O.D. x 18 Ga.
2	59130	Hub and Handle Ass'y.	21	38885	Table Tensioner
3	59525	Index Knob	22	59740	Table Support
4	59832	Spring	23	X-1027	Carriage Bolt 1/4-20 x 1
5	59619	Miter Index Pin	24	59838	Front Table
*6	X-388	Mach. Screw — No. 10-24 x 1/4	25	X-3500	Slot Truss Hd. Mach. Scr. 1/4-20 x 7/8
7	59722	Pointer	26	59640	Table Lock Ass'y.
8	38796	Set Scr. Dog Pt. — No. 10-24 x 3/8	27	59812	Fence
9	59641	Barrel Lock	28	59839	Rear Table
10	59816	Spring	29	59310	Column & Collar Ass'y.
*11	X-291	Cap Screw — 3/8-16 x 3/4	30	59829	Dust Seal
12	X-616	25/64 I.D. x 11/16 O.D.	31	38791	Roll Pin
13	59731	Base Channel (Left)	32	X-2456	Ext. Tooth Lock Washer
14	59625	Barrel Lock (Threaded)	*33	X-636	Washer 13/32 I.D. x 3/4 O.D. x 16 Ga.
15	59626	Flat Hd. Mach. Scr.	*34	X-632	Washer 11/32 I.D. x 1 1/16 O.D. x 1/8
16	X-3808	Set Sc. Cup Pt. — 3/4-16 x 3/8	59939		Instruction Sheet (Not Illus.)
17	59213	Column Support			
18	59732	Base Channel (Right)			
*19	X-420	Hex Nut 1/4-20			

\*Standard hardware items — may be purchased locally.

# CRAFTSMAN 9 INCH RADIAL SAW—MODEL NUMBER 103.29310

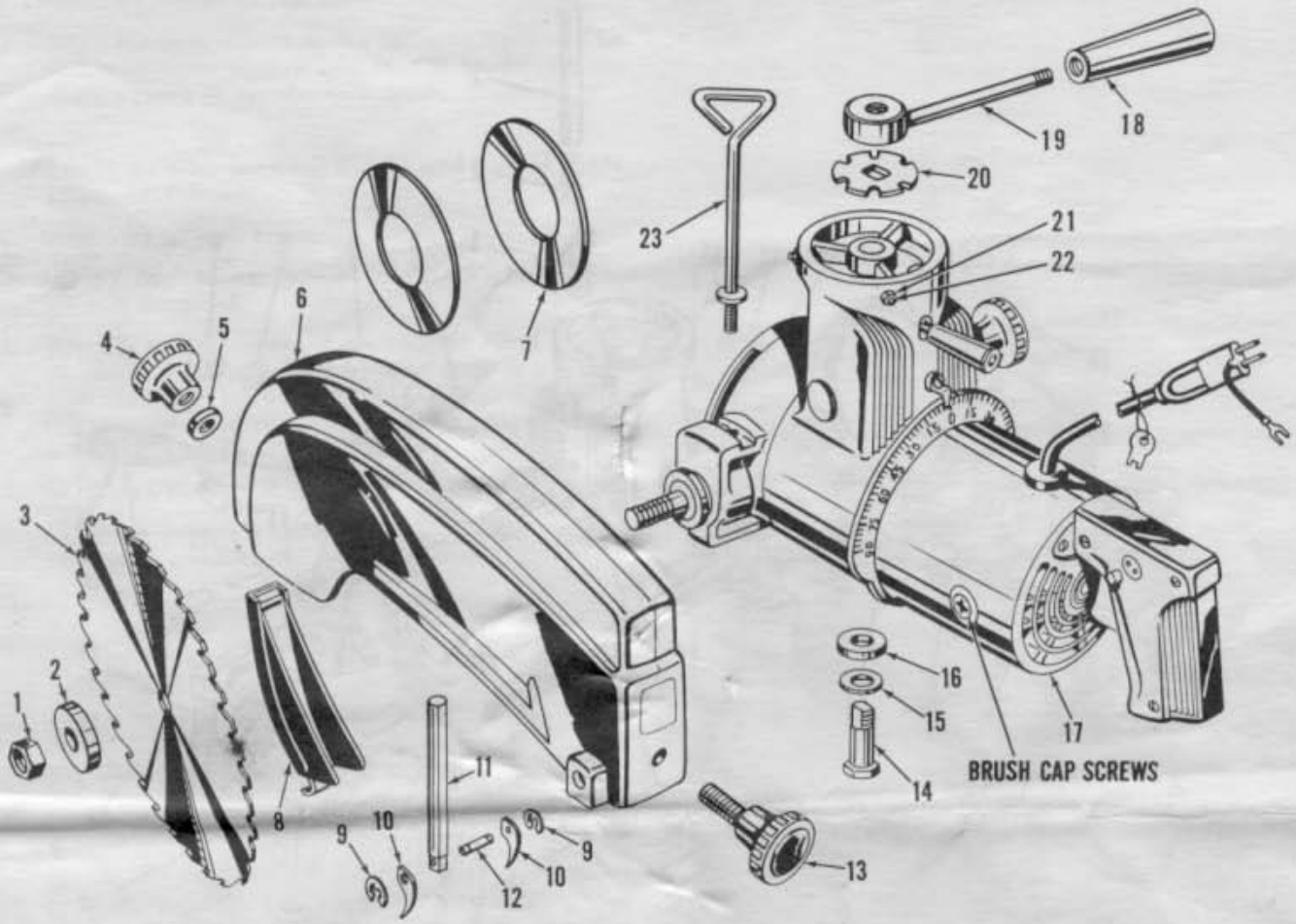

Fig. 3

Key No.	Part No.	Description	Key No.	Part No.	Description
1	59645	Hex Nut	12	59618	Kickback Pivot Pin
2	59646	Saw Clamp Washer	13	59523	Knob
3		9" Saw Blade (avail. at all Sears stores)	14	59633	Pivot Pin
4	59524	Knob	15	38728	Spring Washer
* 5	X-607	Washer 17/64 I.D. x 19/32 O.D. x 18 Ga.	*16	X-647	Washer 21/32 I.D. x 1 1/8 O.D. x 3/32
6	59270	Blade Guard	17	59003	Power Unit
7	59728	Smooth-Cut Collar	18	59643	Knob
8	59730	Saw-Dust Deflector	19	59190	Handle
9	38788	Retaining Ring	20	59721	Pivot Lock Plate
10	59718	Kickback	21	38511	Hex Nut
11	59617	Kickback Rod	22	X-3810	Set Screw
			23	59846	Guard Wrench

NOTE: For any repair on Motor Unit, No. 17, other than the parts shown on page 6, contact your nearest Sears Retail Store or Mail Order House.

\*Standard hardware items — may be purchased locally.

# CRAFTSMAN 9 INCH RADIAL SAW — MODEL NUMBER 103.29310

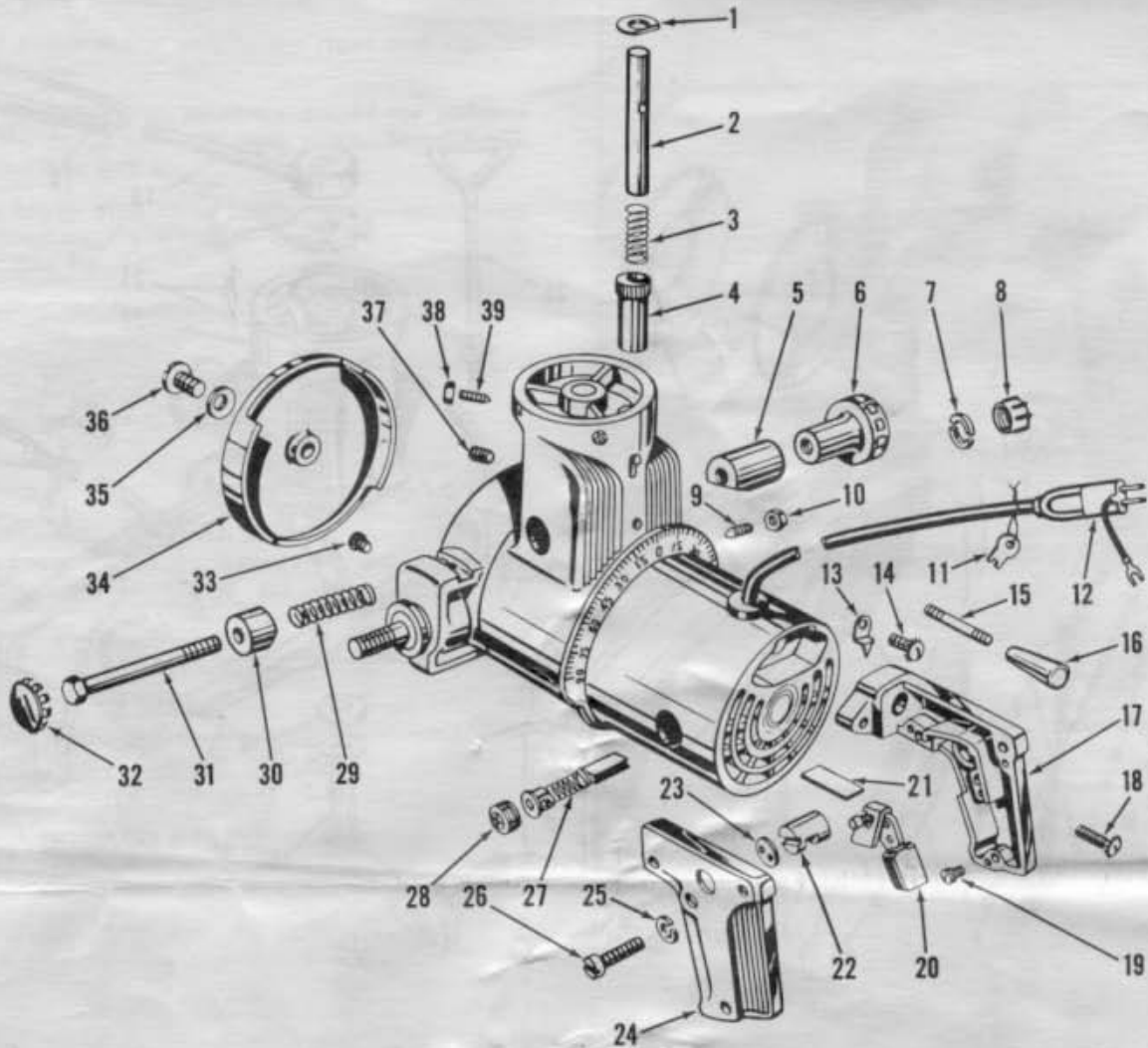

For replacement of the parts listed below contact your nearest Sears Retail Store or Mail Order House.

Key No.	Part No.	Description
1	A-11679	Spring Retainer
2	A-11675	Index Pin
3	A-11678	Spring
4	A-11674	Eccentric Bushing
5	A-11693	Barrel Lock
6	A-11695	Lock Knob
7	A-11720	Retaining Ring
8	A-11719	Cap
* 9	A-11681	Set Scr. 1/4-20 x 3/8
* 10	A-8155	Hex Nut 1/4-20
11	A-11718	Key
12	A-10369	Adaptor Plug
13	A-11716-45	Indicator
14	A-11717	Sems Ass'y.
15	A-11727	Stud
16	59644	Index Handle
17	C-5261	Handle
18	A-11710	Sems Ass'y.
19	A-10614	Self Tapping Scr.
20	B-6388	Switch
21	A-11988	Lock Spring
22	A-11987	Lock Tumbler
23	A-11713	Tumbler Disc
24	C-5262	Handle Cover
* 25	A-10274	Lock Washer 19/64 O.D. x 11/64 I.D.
* 26	A-11715	Machine Scr.
27	A-10330	Brush Spring Ass'y.
28	A-10331	Brush Cap
29	A-11694	Spring
30	A-11692	Barrel Lock
* 31	A-11691	Mach. Bolt
32	A-11696	Hole Plug
33	A-11706	Sems Ass'y.
34	A-11707-44	Air Directional Cap
35	A-11708	Spring Washer
* 36	A-11709	Mach. Scr. 1/4-20 x 1/4
* 37	A-11680	Set Scr. 10-24 x 1/4
* 38	38511	Hex Nut 10-24
* 39	X-3810	Set Scr. 10-24 x 3/8

\*Standard hardware items — may be purchased locally.

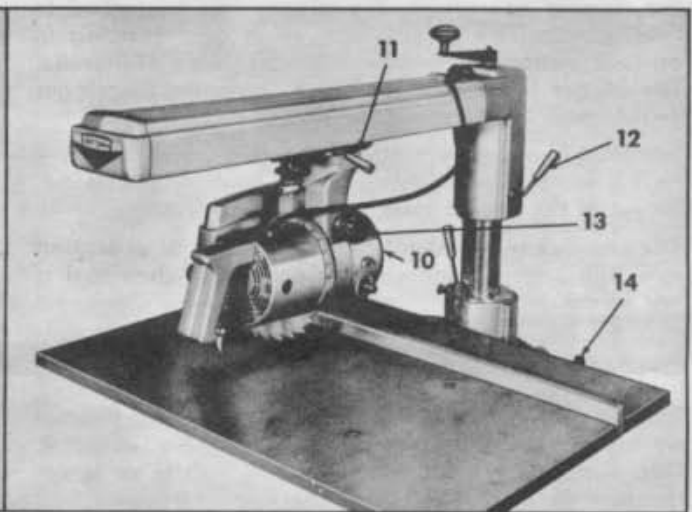
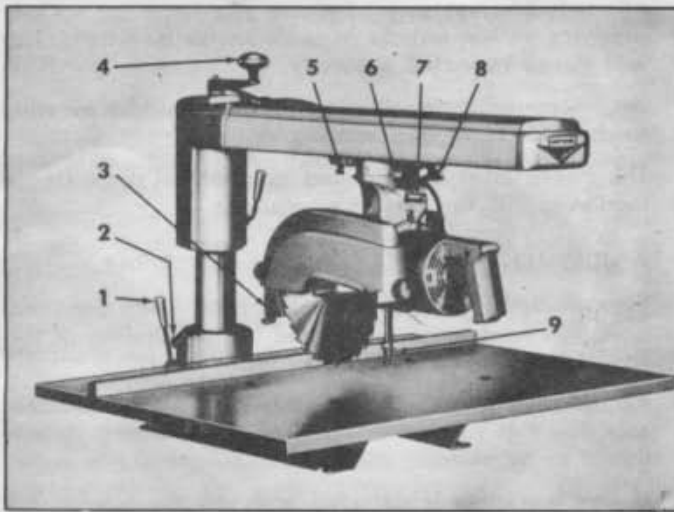

1. ARM SWIVEL LOCK HANDLE
2. ARM SWIVEL INDEX KNOB
3. ADJUSTABLE HOLD-DOWN
4. ELEVATING CRANK HANDLE
5. CARRIAGE TENSIONER KNOB
6. YOKE SWIVEL LATCH PIN
7. INDEX PIN HANDLE

8. CARRIAGE LOCK KNOB
9. ADJUSTABLE KICKBACK
10. AIR DIRECTIONAL CAP
11. YOKE SWIVEL LOCK HANDLE
12. ELEVATING LOCK HANDLE
13. BEVEL LOCK KNOB
14. TABLE CLAMP

Fig. 4

### READ THESE INSTRUCTIONS CAREFULLY

This instruction sheet was written for your benefit. The satisfaction and pleasure you receive from the ultimate use of this tool will largely depend on how accurate you adjust it and how well you maintain it.

Some loose parts which require assembly were packed or wrapped separately. Be sure to inspect all packing material before discarding making sure all saw parts have been removed.

#### MOUNTING THE SAW TO A WORK BENCH

In order to maintain the built-in accuracy of this Radial Saw, the bench to which it is fastened must be of sturdy construction and have a flat surface for mounting the tool.

#### PROPER OPERATING PROCEDURES

Dress properly — operation of this saw is simple, safe and easy. Always be alert. Do not wear a tie or other loose articles of clothing. **NEVER STOP BEING CAREFUL.**

Avoid awkward hand positions — Do not get hands into a position in which a sudden slip can cause them to get close to the saw blade. Never operate the saw with the arms in a crossed position. Never hold work on right side of blade with left hand while pulling saw with right hand.

Use a push stick when ripping narrow pieces.

Never twist work — Twisting work will bind the blade and cause a kickback.

#### LUBRICATION

Your Radial Saw is a precision machine and requires periodic cleaning and lubrication. It is also important **NOT** to apply oil to various spots. Lubricate according to instructions only.

Use any good grade machine oil.

1. Occasionally apply a few drops of oil beneath the elevating handle on top of the arm to washer, No. 6, Fig. 1, and also on the screw thread thru the opening at rear of arm.

2. Keep column clean and occasionally apply a light film of oil on column and particularly the elevating lock keyway.

#### COLOR CODING

All of the operating controls are color coded to indicate those that work in conjunction with one another.

Red — indicates pivoting of motor.

Yellow — indicates swivelling of yoke.

Green — indicates swivelling of arm.

Blue — indicates elevation and elevating lock.

#### TRIGGER SWITCH AND KEY LOCK

Positioning the motor unit for various operations and turning the saw "off" and "on" are controlled thru the pistol grip handle.

A built in trigger switch will provide power as long as it is depressed. Upon release the power is cut off immediately. This Motor is equipped with a Thermal-Overload Protector. If the Motor stalls due to too fast a feed, hitting a knot etc., the trigger switch must be released for an instant before power can be re-applied.

For ripping operations, the trigger can be locked in "on" position by holding trigger in and pressing in on lock button located on left hand side of handle. The trigger is unlocked by merely pressing on trigger switch and letting it retract.

For maximum safety a key is supplied which locks the switch in "off" position. The key hole is located adjacent to the button lock on left side of handle.

The key lock will prevent tampering with or operating saw and prevent unnecessary accidents when tool is not in actual use.

## OPERATING CONTROLS

**Raising and lowering the Radial Arm** is accomplished by turning the elevating crank handle, No. 4, fig. 4. One complete turn of this handle will raise or lower the arm  $\frac{1}{8}$  inch.

**Locking the Radial Arm** after a vertical adjustment has been made is accomplished by the elevating lock handle, No. 12, fig. 4. This lock assures maintaining extreme accuracy for all Radial Saw operations.

**Angular movement and locking of the Radial Arm** are controlled by the arm swivel index knob, No. 2, fig. 4, and arm swivel lock handle, No. 1, fig. 4.

**The Radial Arm will index to three positions**—Approx.  $0^\circ$  which is the normal operating position—and at two  $45^\circ$  positions. To index to any of these three positions pull out on arm swivel index knob and swivel arm to desired location. The knob will automatically stop travel — however, the arm must always be pushed against the stop in a counter-clockwise direction when locking. This will insure repeated accurate settings.

Any position other than these three can be obtained by merely pulling out index knob — swivelling arm to desired position — and locking securely with swivel lock handle.

All settings are indicated by the scale and pointer surrounding the column at top of base casting.

**Movement and positioning of the motor unit** is accomplished as follows:

The entire unit can be easily rolled forward and backward on arm and locked in any position with the carriage lock knob No. 8, fig. 4.

By grasping the pistol grip handle the motor can be swivelled right or left in the following manner:

Unlock the yoke swivel lock handle No. 11, fig. 4. The motor unit can then be swivelled to the right until automatically stopped at  $90^\circ$ . The unit may also be locked at any intermediate position.

Returning to the normal position the motor unit will automatically stop with the blade parallel to the arm. To swivel to the left side, the latch pin, No. 6, fig. 4, must be pushed up and the motor unit will swivel and lock at any desired angle.

The motor unit can be pivoted and locked at any angle in either direction.

To pivot to the left, loosen bevel lock knob, No. 13, lift the index pin handle, No. 7, and grasping the handle turn in a counter-clockwise direction. The motor will automatically index at  $0^\circ$  -  $45^\circ$  and  $90^\circ$ .

When locking at any of these positions exert slight pressure on the handle in a clockwise direction. This will insure repeated accuracy.

Any intermediate position can be attained by pivoting to desired angle and locking.

The guard must be removed to rotate in opposite direction to  $90^\circ$  for routing operations.

## ADJUSTMENTS TO COMPENSATE FOR WEAR

Even though the finest materials have been used and precision workmanship applied in the building of this saw it is reasonable to expect some wear.

Adjustments have been built into your saw to compensate for this normal wear. Make necessary adjustments as required.

**If any looseness is detected between the power unit and the tubes in the arm on which it rides adjust as follows:**

1. Remove carriage tension knob A, fig. 5, and carriage lock knob B, fig. 5.
2. Loosen the six lock nuts, C, fig. 5. — Note the slotted head set screws.



Fig. 5

3. Adjust each of the slotted head set screws — ONE PAIR AT A TIME — until all excessive play is removed and the unit still rolls freely on the tubes.
4. Holding each of the set screws in the adjusted position with a screw driver re-tighten the lock nuts.
5. Re-install carriage tension knob and carriage lock knob.

**Any looseness between radial arm and column can be removed as follows:**

1. Remove elevating lock handle, see fig. 6.
2. Loosen the lock nut.
3. Using a screw-driver, adjust screw to remove play.
4. Re-tighten lock nut while holding screw in adjusted position and re-insert handle.

Excessive play or back-lash in elevating handle can be removed by tightening the hex lock nut on top until desired tension is obtained.

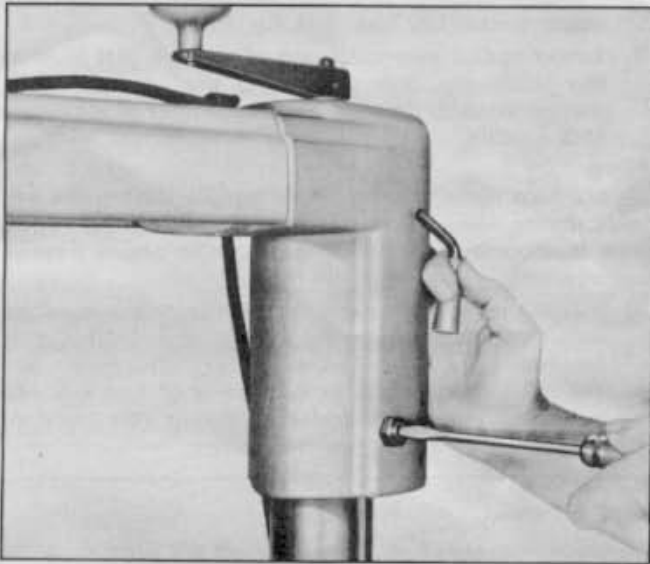

Fig. 6

If not enough locking pressure can be obtained with yoke lock handle, re-adjust as follows:

1. Loosen yoke lock handle.
2. Loosen and remove lock screw, A, fig. 7, which engages one of eight notches in lock plate.
3. Turn hex head bolt, A, fig 8, to the right until next notch in lock plate, see fig. 7, can be engaged by screw previously removed.

**Note:**

You will notice that one notch is aligned with rib, see fig. 7. Turning hex head bolt to the right until next notch is in line with rib automatically aligns the proper notch for engagement of lock screw.

4. Re-tighten the lock screw.
5. Any subsequent adjustment can be made in the same manner

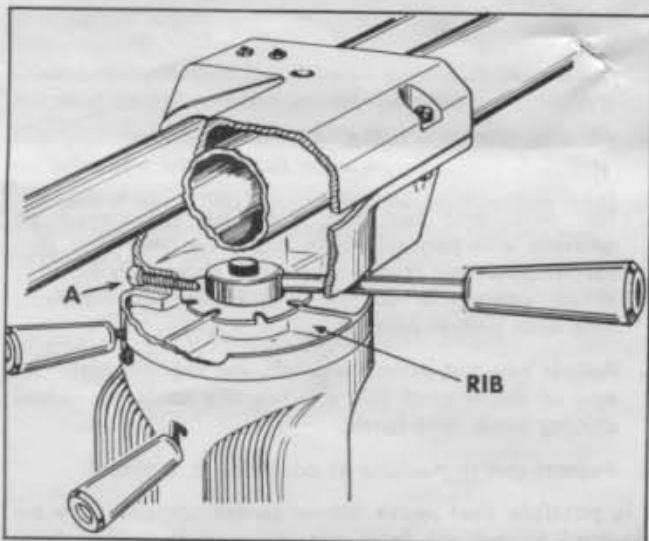

Fig. 7

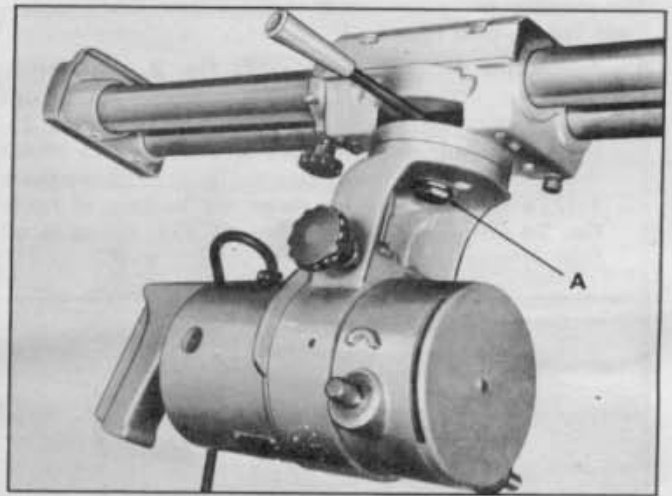

Fig. 8

If the Arm Swivel Lock Handle requires adjustment proceed as follows:

1. Remove slotted head set screw (No. 16, Fig. 2).
2. Loosen machine screw (No. 15, Fig. 2).
3. Hold arm swivel lock handle in a straight up position and re-tighten machine screw securely.
4. Re-install set screw and tighten securely. This will be the locked position.

**REPLACING THE BRUSHES**

The brushes should be checked periodically and if worn to less than 1/8 inch in length should be replaced.

Always replace brushes in pairs.

If brushes require changing proceed as follows:

1. Remove two brush cap screws, (See Fig. 3), one on each side of motor.
2. Remove brushes and replace with new ones.
3. Replace two brush cap screws.

**Note:**

If for any reason the brushes are removed for inspection always replace each one the same way they came out.

**ASSEMBLY-ADJUSTING**

**INSTALLATION OF TABLE AND FENCE**

**Note:**

This table top is not warp-proof but is as warp resistant as modern day technology permits.

The complete machine is manufactured to a high degree of accuracy so that a slightly warped table will not appreciably affect the end results.

The amount of distortion and warpage will vary depending on the atmospheric conditions such as high humidity or extreme dryness. This cannot be controlled by the manufacturer.

The proper method for checking the table top for warp is to lay a straight-edge on the table from one corner to the corner diagonally opposite. Anything up to 1/8 inch warp will not materially affect the cut.

The wooden table consists of three pieces—Front table—Rear Table—and Fence.

1. Fasten the Front Table No. 24 Fig. 2 with chamfered edge toward front of tool to the table supports with the four truss head screws, No. 25. Using the four thin washers  $\frac{3}{4}$  O.D. No. 33 under the head of each screw. Use the four thick washers  $1\frac{1}{16}$  O.D. No. 34 between the bottom of table No. 24 and table support No. 22 Fig. 2. Leave all four screws loose.

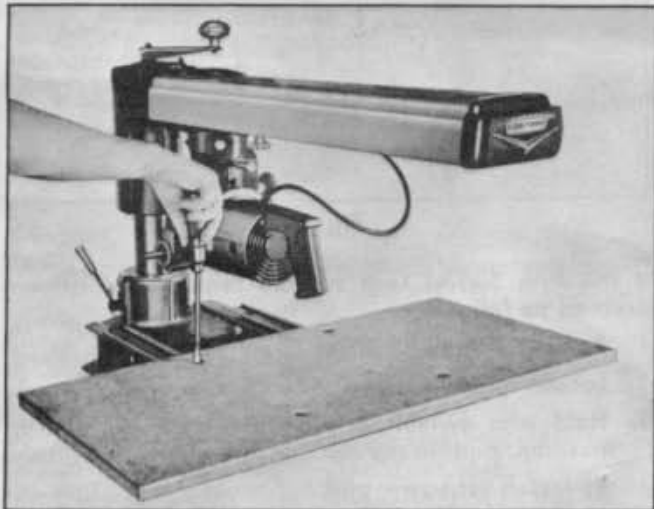

Fig. 9

#### ADJUSTING FRONT TABLE

1. Place wrench over shaft and hold securely with collar and arbor nut. See Fig. 12.
2. Set the Radial Arm  $0^\circ$  and tighten arm swivel lock handle. Check Pointer to see if it indicates  $0^\circ$  accurately. See operating controls on page 8.
3. Using a combination square as shown in Fig. 10, adjust the front table until the edge of wrench just touches the square as the Motor Unit is pulled back and forth.
4. Tighten the four truss head screws securely.

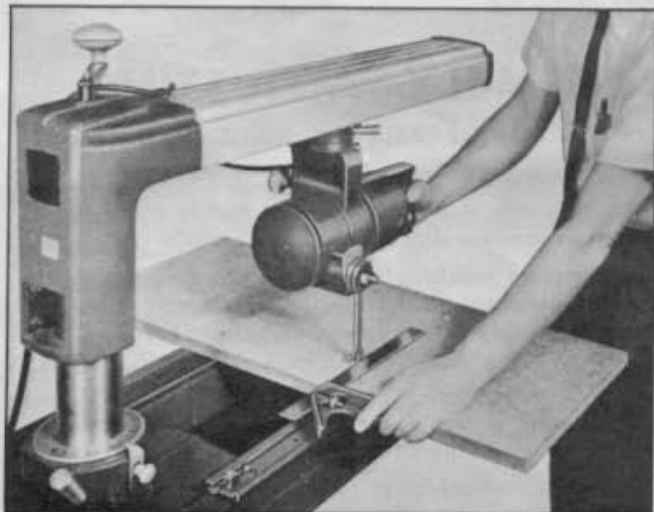

Fig. 10

#### ADJUST TABLE PARALLEL TO RADIAL ARM

Read carefully the paragraph under "Operating Controls" on page 8 regarding indexing the Radial Arm.

1. Place wrench over shaft and hold securely with collar and arbor nut. See fig. 11.
2. Lower radial arm until end of wrench just touches the table top thus permitting the wrench to be swung back and forth. See fig. 11. Lock elevating lock handle.

#### Note:

Do not turn the elevating crank handle during the adjustment of table at the four positions as the radial arm must remain at the same height to assure overall parallelism.

3. Using the wrench as a gage, the table must be adjusted up or down by means of four hex nuts located inside the table support channels. See fig. 12. Usually one or two turns of hex nut will put neoprene pads under sufficient compression.



Fig. 11

4. The arm and carriage must be positioned so wrench will contact table top over the four different positions in the sequence shown in fig. 11. When wrench is located at number one position, lock arm swivel handle.
5. Adjust hex nut below wrench, see fig. 12, until the end of the wrench just touches the table top when swung back and forth.
6. Repeat this procedure at positions 2, 3 and 4.

It is possible that some minor re-adjustment may be required to put all four neoprene pads under compression.

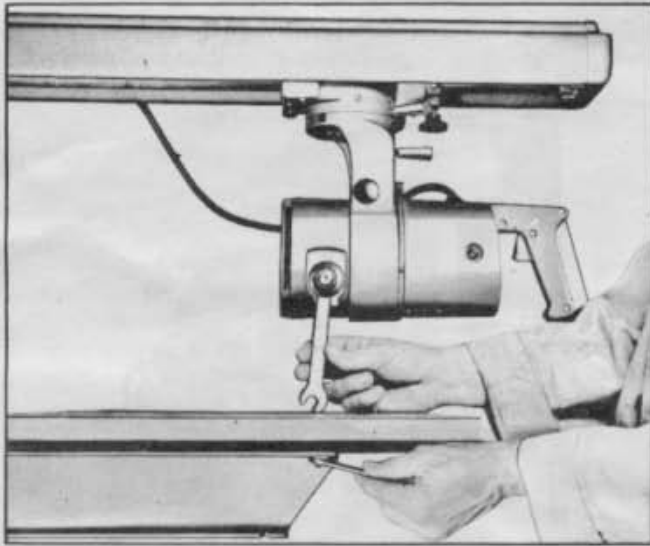

Fig. 12

1. Assemble the Fence and Rear Table as shown in Fig. 4.
2. Install the Table clamp assemblies in the key-holes as shown in Fig. 10, and lock Rear Table and Fence in place.

Note: Two additional key-holes are provided in the table supports. This allows Rear Table and fence to be removed for certain molding operations.

### INSTALLATION OF SAW BLADE

#### Read Carefully:

Two smooth cut collars (No. 7, Fig. 3) are supplied as standard equipment. These collars should be used at all times unless a greater depth of cut is required at which time they can be removed.

The purpose of these collars is to put proper tension on the saw blade which eliminates all flutter and thereby produces a smoother and more accurate cut.

The smooth cut collars should be installed, one on each side of the blade with the convex side out. They will automatically be centered when installed by the machined diameter of the arbor collar on the inside and the saw clamp washer on the outside.

The hex nut should be tightened securely in order to collapse the smooth cut collars.

We recommend NOT installing the two collars until all adjustments have been made and the tool is ready for operation.

1. Remove wrench from arbor.

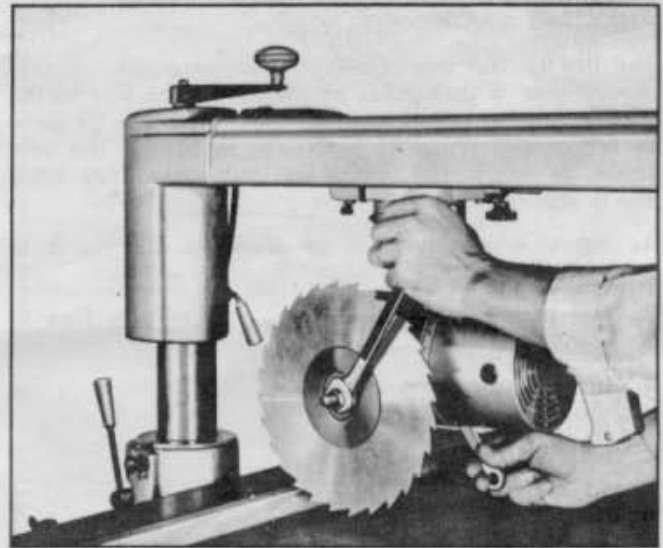

Fig. 14

2. Place the saw blade on motor arbor making sure the teeth are pointing in the same direction as shown in fig. 14.
3. Install saw clamp washer over arbor and lock blade securely with hex nut. (This is a left hand thread and tightens in a counter-clockwise direction).

#### Note:

The wrench supplied fits over the flat on arbor at opposite end when tightening saw arbor nut.

### CONNECTING THE MOTOR TO THE POWER SUPPLY MOTOR SPECIFICATIONS

115 Volt, 8 Amps, 60 Cycle (A. C. Only), Non-reversible.

An adaptor plug is furnished as standard equipment. Ground pig-tail wire according to instructions fastened to motor cord.

Important: The following wire sizes are recommended for connecting the motor to a power source for trouble free operation.

Length of Conductor	Wire size required (American wire gauge No.)
115 Volts	
50 Feet or less	No. 12
100 Feet or less	No. 10
100 Feet to 150 Feet	No. 8
150 Feet to 200 Feet	No. 6
200 Feet to 400 Feet	No. 4

For circuits of greater length the wire size must be increased proportionately.

**PRELIMINARY CROSSCUT AT THE 0° POSITION  
AUXILIARY TABLE**

The life of the saw table can be permanently preserved if a 3/8 inch piece of plywood is tacked to the table top after leveling. Then all cutting can be done in the added piece of plywood instead of the saw table. A sketch of a more desirable auxiliary table top is shown in fig. 18.

1. Attach blade guard with screw No. 23, fig. 3, to motor. See fig. 15.
2. Pull motor forward of fence so blade is free to rotate.
3. Lower radial arm until saw blade just clears the table top.
4. Tighten carriage lock knob.

**Caution:**

Make sure arm swivel lock handle is securely tightened.

5. Plug in cord for power.
6. Start motor with trigger switch and lock in "on" position with button lock.
7. Lower radial arm until blade cuts into table top or auxiliary table top if used 1/32 inch. (THIS IS ALL THAT IS NECESSARY). See fig. 16.
8. Tighten elevating lock handle.

To cut a blade clearance groove in the table and fence hold pistol grip handle and loosen carriage lock knob. Slowly pull the motor out to the extreme end of travel and then push the motor back through the fence to the extreme rear position. Turn motor off. See fig. 17.

The initial cut at any other angle will require following the same procedure as described above.

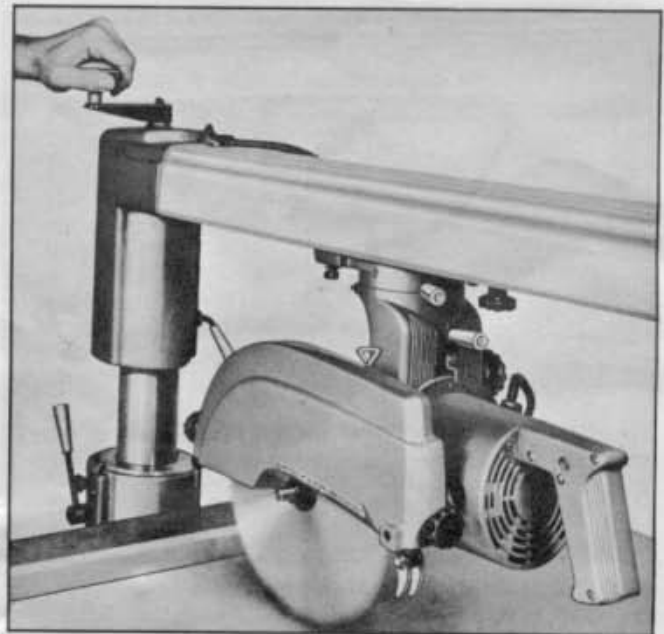

Fig. 16

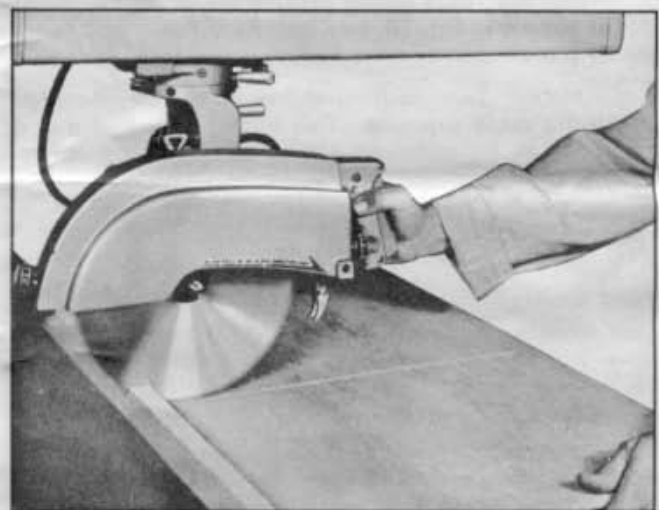

Fig. 17

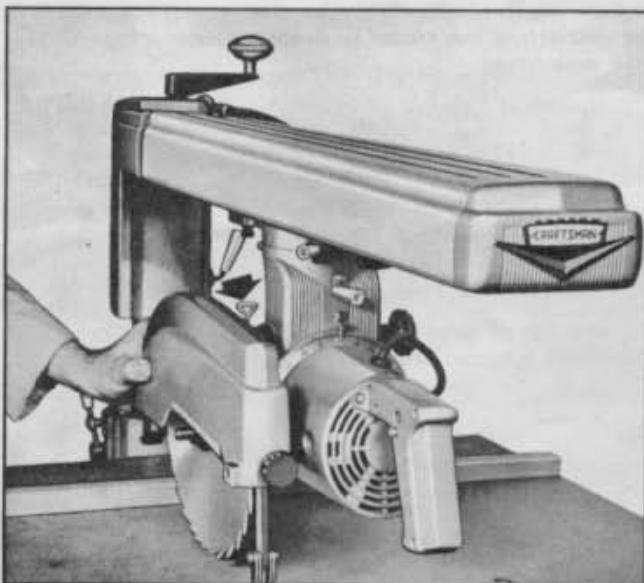

Fig. 15

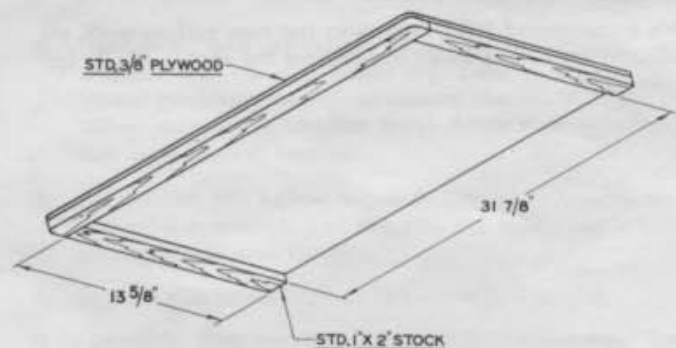

Fig. 18

## CHECKING THE SAW BLADE FOR HEEL

(Left and Right)

Using a scrap piece of lumber approximately six inches wide, lay it on the table against the fence on the left side of the blade. Position board to permit a three-inch piece to be cut from the right and holding the board firmly against the fence with the left hand. Turn the motor on and commence the cut by pulling the saw forward through the board until the front half of the saw blade clears as shown in view A. Turn motor "off" and allow the saw blade to come to a complete stop while the rear portion of the blade is still in contact with the wood. Marks on the face of the board indicate left heeling. Check face of cut board. See view A. To check for right heeling repeat the same cut from the right side of the blade. Check for heel marks. See view B.

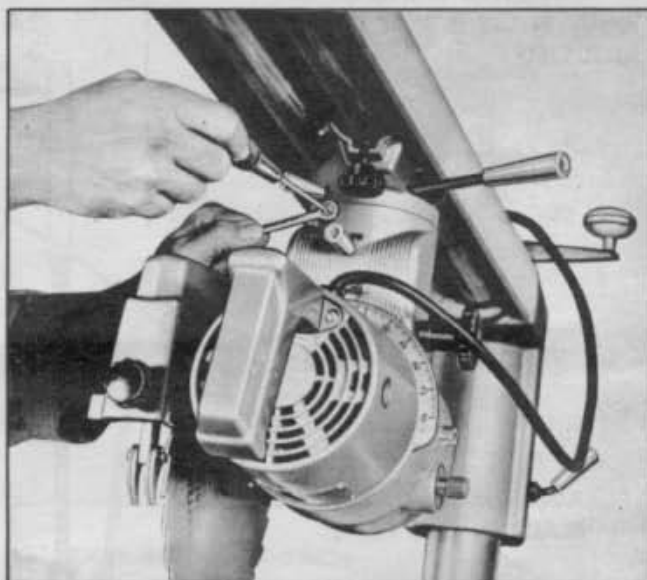
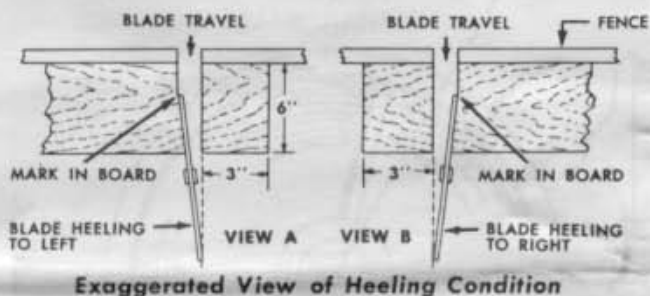

Fig. 19



Exaggerated View of Heeling Condition

An alternate method for adjusting for heeling is shown in fig. 20. Place the square against the fence and hold against the saw blade. Make sure the edge of square is not touching the tooth points. Adjust the screw as shown in fig. 19 until blade is flush with square. If this method is used the blade must be squared to the table top as shown in fig. 22.

### Note:

The piece of wood must be held firmly against the fence and not permitted to move while the saw is coming to a stop.

To correct for heeling proceed as follows:

1. Loosen yoke swivel lock handle.
2. The one screw in fig. 19, is used. Unlock hex nut in fig. 19.
3. For blade heeling to the left turn screw out (counter-clockwise) very slightly. For heeling to the right screw must be turned in (clockwise) very slightly. Lock with hex nut.
4. Hold motor unit against stop in a clockwise direction and relock yoke.
5. Recheck as before to see if condition is corrected.

Refer to page 14 for illustration which further explains this adjustment.

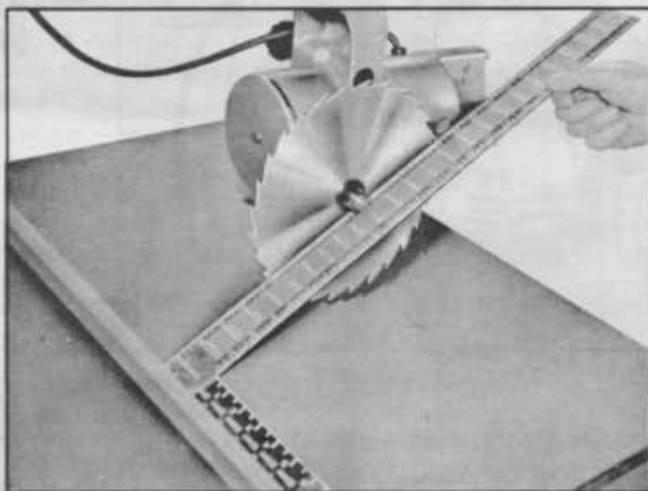

Fig. 20

EXAGGERATED WIDTH OF CUT—  
WHEN BLADE IS NOT PROPERLY  
ADJUSTED

WIDTH OF CUT — WHEN BLADE  
IS PROPERLY ADJUSTED

ADJUSTMENT OF SCREWS MOVES  
BLADE IN THIS PATH

1. When blade is properly adjusted the kerf (width of cut made by saw blade) should be only as thick as the blade including the set of the teeth.
2. THIS ADJUSTMENT IS IMPORTANT. The adjusting screw shown in illustration below must be turned in or out so that when motor is indexed the index pin which contacts the end of screw will bring the blade into proper alignment. Slight misalignment will cause work to splinter.

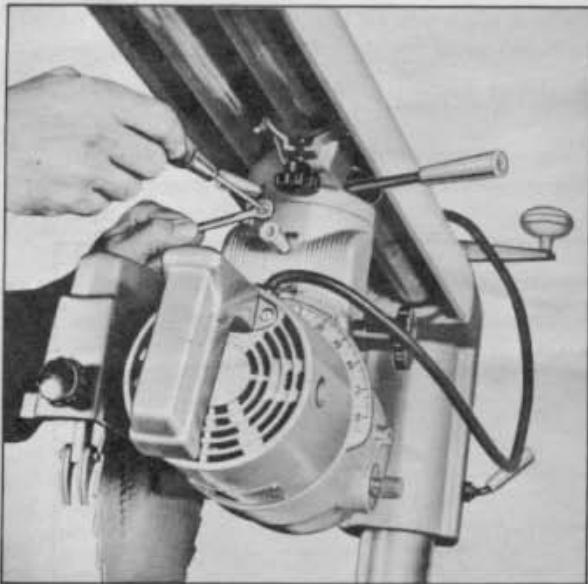

ENLARGED VIEW AT RIGHT SHOWS  
FUNCTION OF ADJUSTING SCREW  
ON INSIDE OF YOKE CASTING

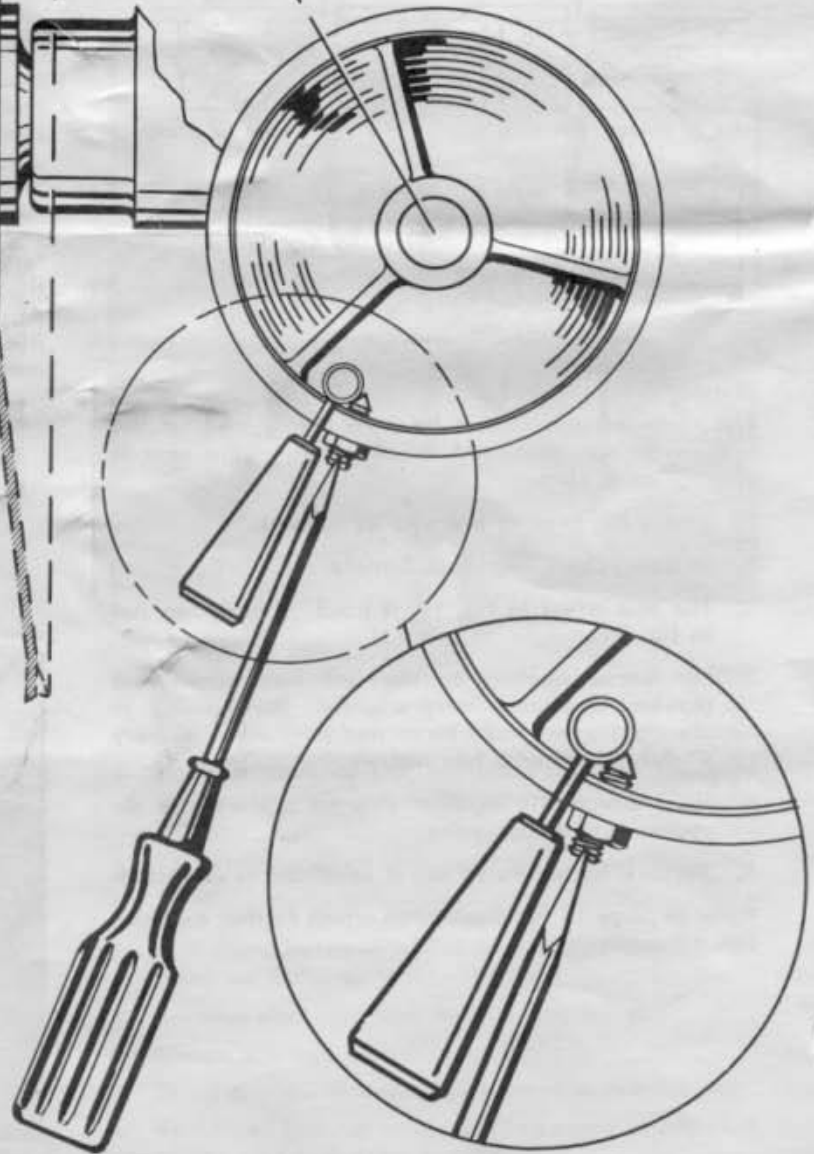

## SQUARING THE SAW BLADE TO THE TABLE TOP

1. Place combination square on table and against blade as shown in fig. 22.
2. When blade is square to the table no light will be visible between square and face of blade. Do not allow square to rest on saw teeth.

If light is visible between square and face of blade adjust as follows:

1. Loosen bevel lock knob.
2. Loosen hex socket screw in fig. 21, with hex wrench supplied.
3. Using a pair of pliers, turn knurled head in fig. 22, while holding motor against stop in a clockwise direction by use of the pistol grip handle. The knurled head can be turned in either direction to bring the blade square to table top.
4. Re-tighten bevel lock knob.
5. Retighten set screw in fig. 21, and recheck squareness with combination square.
6. Adjust pointer to indicate  $0^\circ$  if necessary.

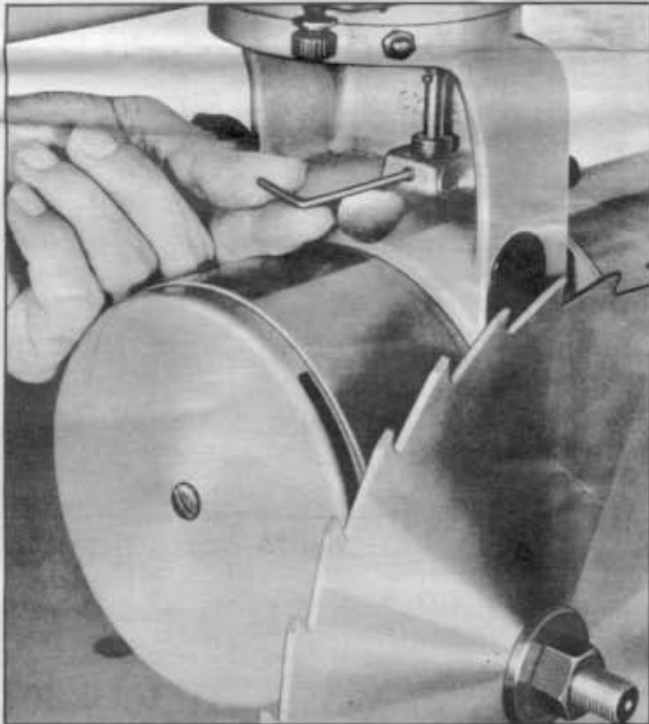

Fig. 21

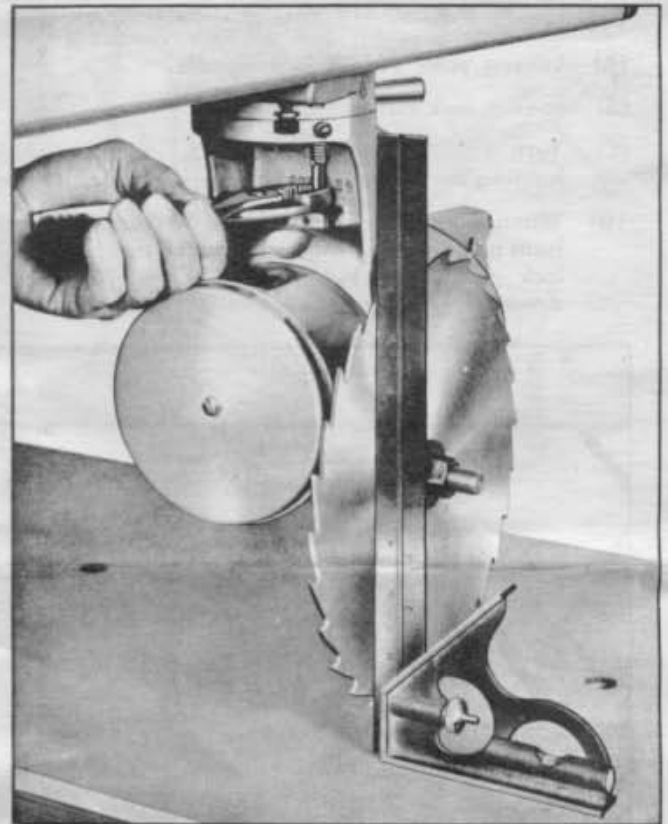

Fig. 22

## PARALLELING THE BLADE TO THE FENCE

1. Loosen yoke swivel lock handle.
2. Swivel entire motor unit to the right and against the 90° stop.
3. Using a combination square, measure the distance from the fence to "one" saw tooth. See fig. 23. Lock carriage lock knob.
4. Rotate blade until same tooth is on opposite side and measure the distance from fence to blade tooth. See fig. 24.

Any variation can be removed in the following manner:

- (A) Loosen yoke swivel lock handle.
- (B) Loosen lock nut in fig. 25.
- (C) Turn adjusting screw in fig 25, in or out while holding motor under slight pressure against stop.
- (D) When measurement of fence to same tooth in both positions are the same relock the screw with lock nut while holding set screw with screw driver.

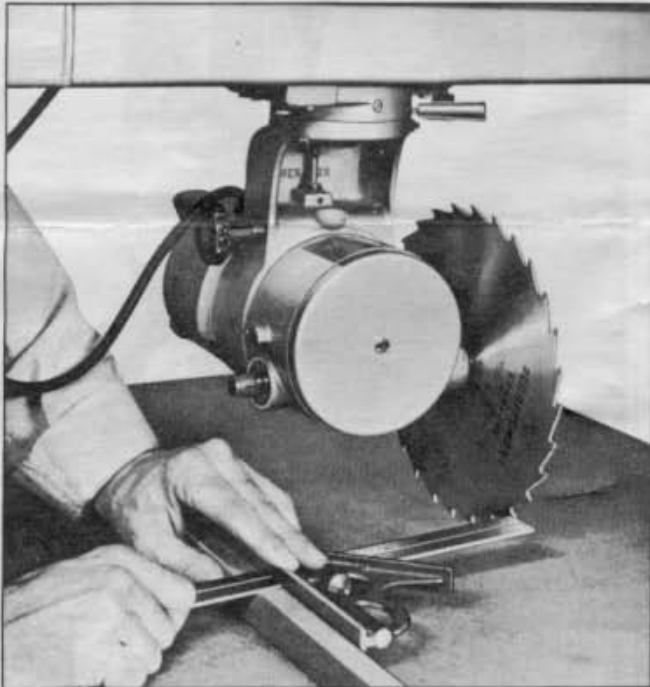

Fig. 23

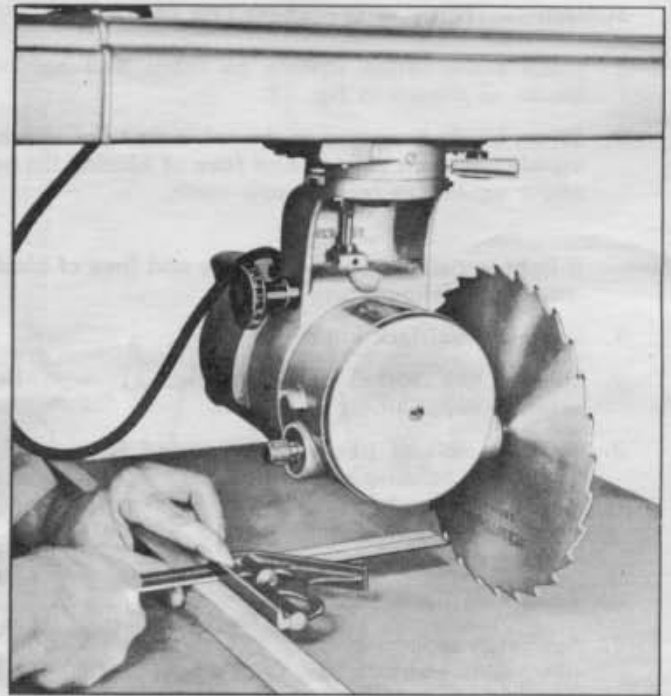

Fig. 24



Fig. 25

## STANDARD SAW OPERATIONS

### CROSS - CUTTING

Cross-cutting is the sawing of wood across the grain. Planks are milled with the grain running the length of the plank. If a straight cross-cut is desired, the board is placed on the saw table against the fence so that the grain is parallel to the fence.

#### Note:

When cross-cutting normal pieces of lumber, the long end of the board should be placed to the left of the

saw blade as the board is usually held by the left hand during operation.

The radial arm must be positioned at 0° as indicated by the radial arm position indicator. The arm lock handle must be tightened. The yoke must be indexed to the 0° position (blade parallel with arm) and the yoke swivel lock handle placed in locked position. The bevel index scale should read 0° and the unit locked in this position. Loosen the elevating lock handle and

turn the elevating crank handle to lower the saw until the blade teeth are approximately 1/32 inch below the table surface and ride in the saw slot made when performing the "Preliminary cross-cut at the 0° position." Push the saw carriage to the rear of the radial arm so the blade is behind the rip fence. Make sure kick back pawl and hold-down are fully retracted. Grasp the pistol grip handle and start motor. Hold the board firmly against the rip fence with the left hand and the cut is made by pulling carriage forward until saw blade cuts through the work.

When the cut is complete release trigger switch and return blade to back of radial arm.

When more experience is gained by using the saw, it will be noticed, that when pulling the saw toward you during cross-cutting, the saw blade tends to feed itself through the work due to the rotation of the blade and the direction of feed.

The carriage tension knob, No. 5, fig. 4, can be adjusted to suit the individual to retard this effect. It will become apparent that very little effort is required on the part of the operator to move the saw blade through the work and in most cases the right arm is used merely to control the rate of feed of the saw through the board. Over feeding will stall the motor. This must be avoided whenever possible.

In some cases it may be necessary to cross-cut long boards which extend over the saw table on one or both sides. This can cause buckling of the board during the cut. To eliminate this condition the ends of the board should be supported.

### RIPPING

Ripping is the sawing of wood with the grain. It is always done with the help of the fence as a guide to position and maintain the work at the correct width for the cut. Because the work is pushed along the fence, it must have a reasonably straight edge to make sliding contact with the fence. Also the work must make solid contact with the table so that it will not wobble or rock. Provide a straight edge, even if this means temporary nailing of an auxiliary straight edged board to the work. If work piece is warped, turn the hollow side down.

Use of the saw guard is always recommended; and the anti-kickback pawl assembly should always be used in ripping operations.

Before ripping and after the saw has been positioned prior to cutting properly adjust the pawl assembly — tips of pawl should be 1/8 inch below the top surface of board to be cut. Then adjust the holddown by loosening holddown lock knob — lowering the hold-down to within 1/8 inch of work and locking securely.

#### Caution:

Observe and obey warning labels on guard.

### BEVEL AND MITER CUTS

Bevel cuts can be made from either a cross-cutting or ripping position by tilting the blade to the desired angle. Miter cuts can be made only from a cross-cutting position where the blade and radial arm are at some angle other than 90° to the fence. A bevel miter cut is a cut which is both beveled and mitered.

This cut is made with the blade and radial arm set at the desired miter angle to the fence and then the blade only is tilted with respect to the table top to the desired bevel angle. This cut is also referred to as a compound miter.

### SANDING

Using the sanding disc mounted on the saw motor, you can convert your saw into a sander which can be operated in nearly any position.

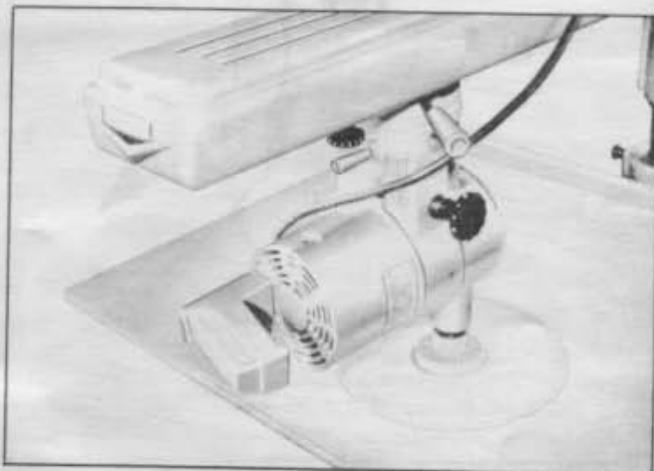

### BORING

Your saw can also be converted to a horizontal drill for boring by using one of the recommended chucks and the proper drill.

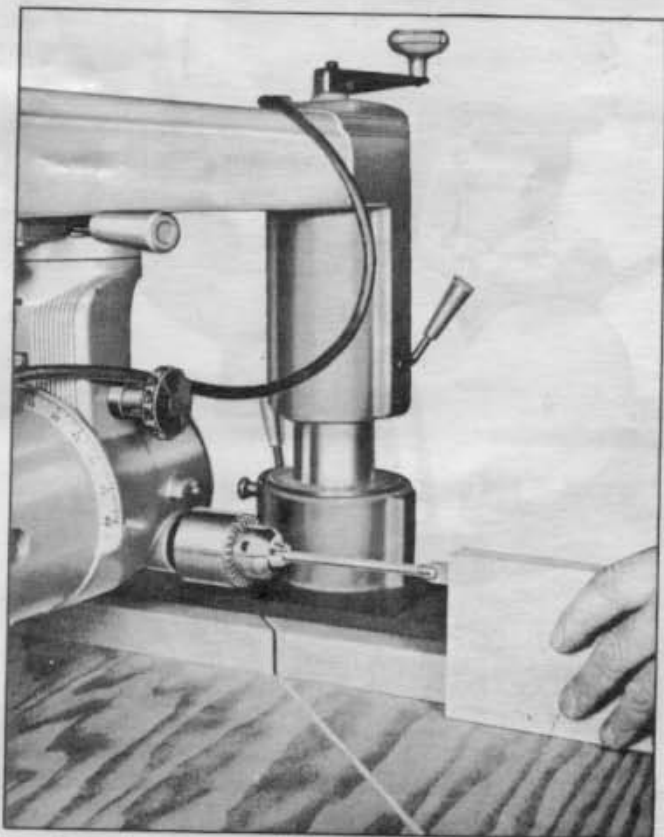

## MOLDING OR SHAPING

This work is done using the Craftsman Molding Cutter Head and a set of cutters depending on the type of molding cut desired. To use the molding cutter head accessory cut a rectangular slot in the rear table— $2\frac{3}{8}$  back from the fence and 5 inches long—under the spindle for clearance. To obtain a minimum cut with some blades the arm may require pivoting to approximately  $10^\circ$ .

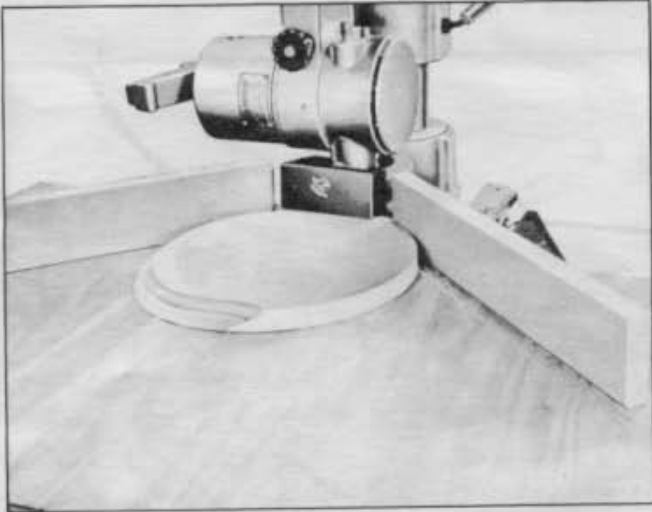

## USE OF THE DADO HEAD

The dado saw or head, as it is called, is a special set of blades for cutting grooves or dados. A Craftsman 6 inch Kromedge Dado Set can be purchased at any Sears Retail Store, or Mail Order House.

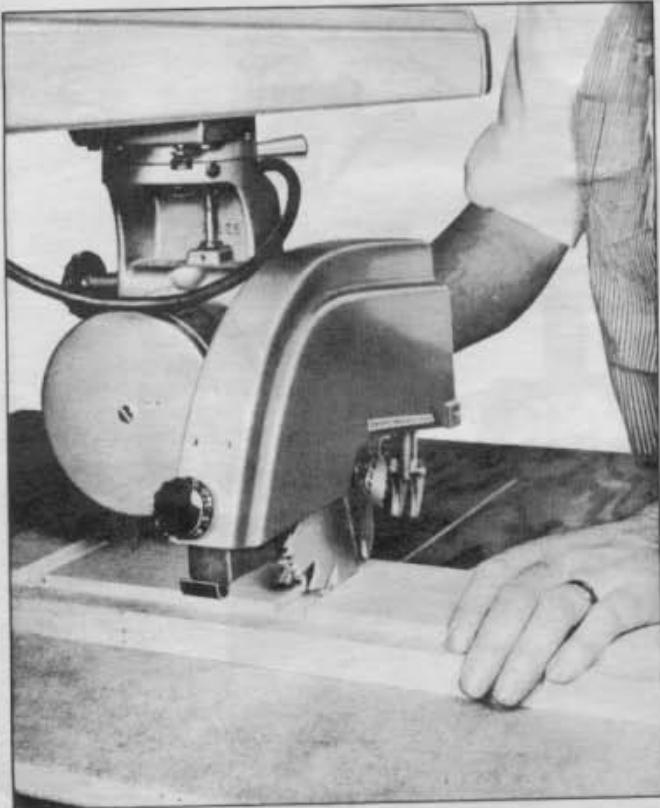

## PLUS MANY OTHER CRAFTSMAN ACCESSORIES

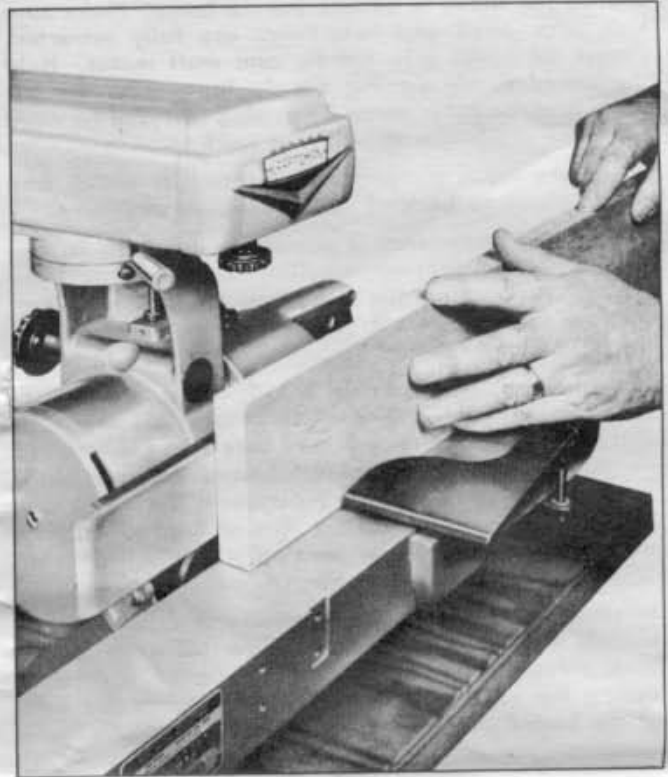

## JOINTING

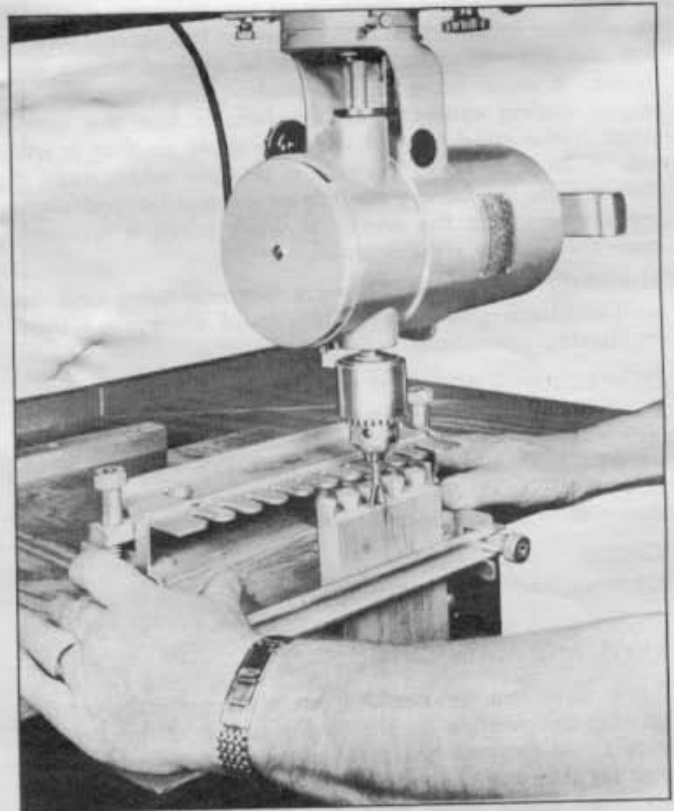

## DOVETAILING

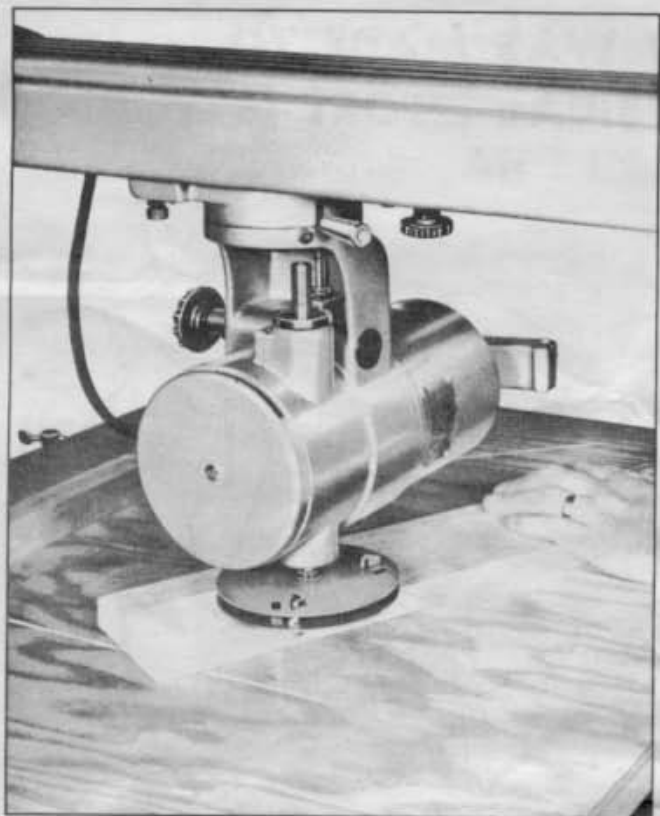

PLANING

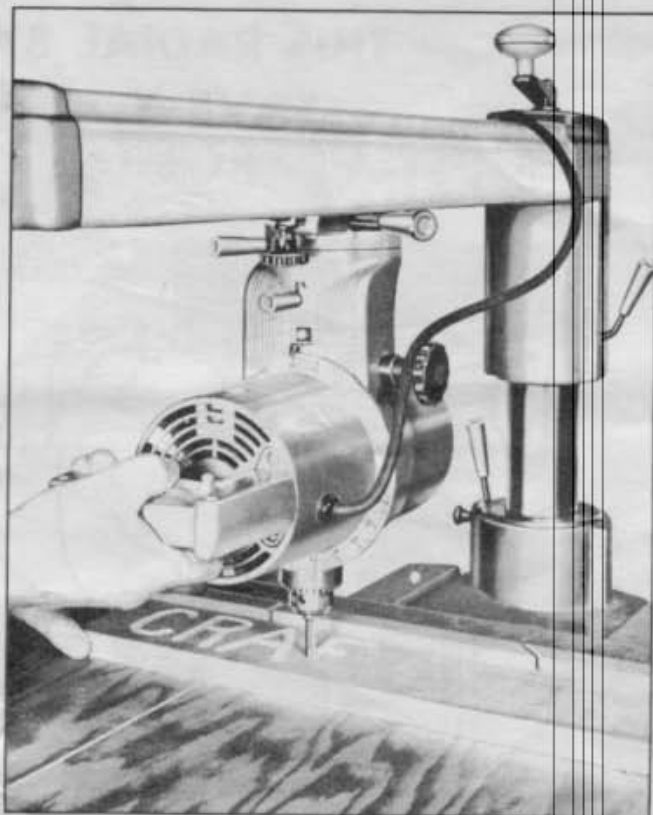

ROUTING

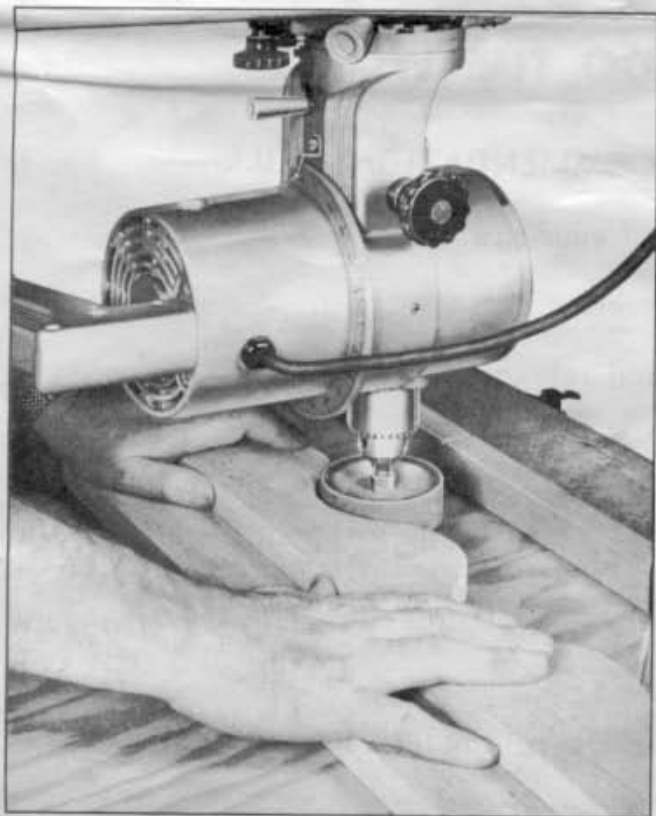

DRUM SANDING

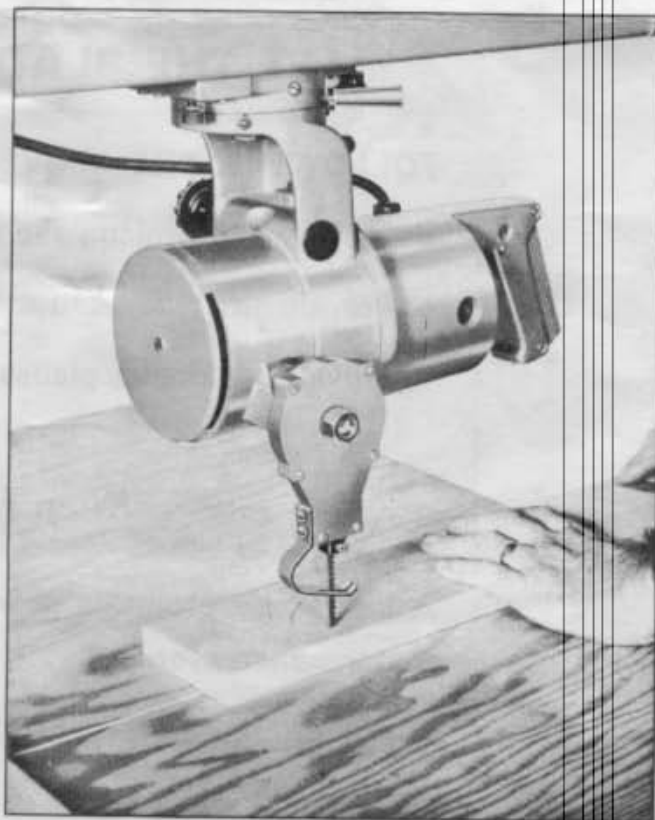

JIG-SAWING

## THIS RADIAL SAW WAS MADE TO SAVE YOU PHYSICAL EFFORT

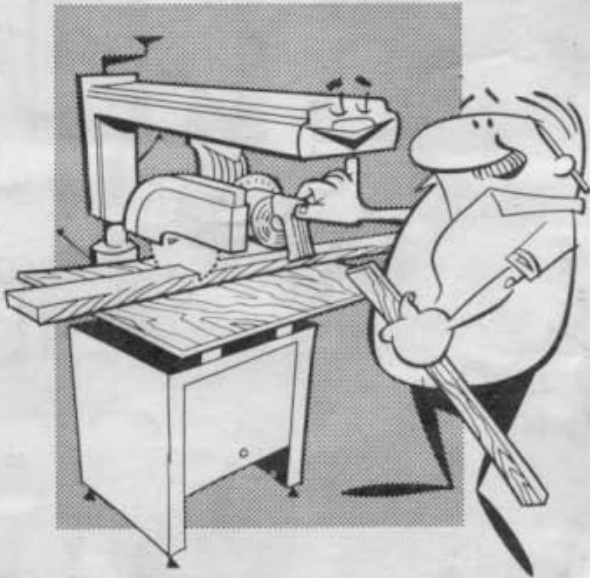

GUIDE ONLY — DON'T FORCE



A CARELESS ABUSER

## LET THE BLADE DO THE WORK

FOLLOWING THE ABOVE RECOMMENDATIONS WILL—

- Protect and prolong the life of your saw.
- Provide smoother and more precise cuts.
- Provide maximum pleasure and relaxation.

### *Keep Blade Sharp*

A dull blade produces poor work and tends to overload the motor unnecessarily.

When all else fails, refer to the Operating Instructions and relax and enjoy the saw.

Most of your radial arm problems can be answered in this manual.